

MT 180

MODELS
36V | 48V



ROBUST AND NIMBLE, THE KEY TO LEAN MANUFACTURING.

This hardworking tow tractor delivers outstanding performance. With its efficient motor and 10,000-lbs. towing capacity, the MT-180 is ideal for moving trailers. It's also narrow enough to fit through most door openings. From its all-steel construction to its all-wheel braking, this tugger is built for years of heavy use in total comfort and safety. All this combined with superior AC technology makes short work of tough requests.

MODELS	LOAD CAPACITY (lbs.)	TOWING CAPACITY (lbs.)	PASSENGERS	SPEED (mph)	TURNING RADIUS (in)
36V	500	10,000	1-2	8	71
48V	500	10,000	1-2	8	71

FEATURES

- Maintenance free AC motor **1**
- AC controller with sealed connectors paired with multifunction display **2**
- Long-lasting, battery-saving LED lights **3**
- Onboard / portable high frequency PFC battery charger **4**
- Automatic parking brake **5**







CONTACT US 1 866 846-3558

MOTREC.COM

SPECIFICATIONS

MT 180

PERFORMANCE		36V	48V
 LOAD CAPACITY		500 lbs – 227 kg	500 lbs – 227 kg
 TOWING CAPACITY		10,000 lbs – 4,536 kg	10,000 lbs – 4,536 kg
 SPEED		8 mph – 13 km/h	8 mph – 13 km/h
 TURNING RADIUS		71" – 1,803 mm	71" – 1,803 mm
 PASSENGERS		1-2	1-2
POWERTRAIN			
MOTOR	Brushless AC motor	10 HP	15 HP
CONTROLLER	Electronic AC speed controller	✓	✓
DRIVE AXLE	Helical gear differential	✓	✓
BRAKES	Front drum brake, Regenerative braking, electromagnetic parking brake	✓	✓
WHEELS	4.8x8 LRC pneumatic tires	✓	✓
TRANSMISSION	Direct drive	✓	✓
SUSPENSION	Coil spring and shock absorbers on front, leaf spring on rear	✓	✓
CHASSIS			
BODY	All-steel unibody construction, powder coating	✓	✓
COLOR	Security orange or federal yellow (optional colors available)	■ ■	■ ■
LIGHTS	Dual LED headlights & tail/brake lights	✓	✓
OPERATOR COMPARTMENT			
STEERING	Handlebar	✓	✓
SEATS	Bucket seat on slide adjusters	✓	✓
INDICATORS	Multifunction display including speedometer, battery state of charge, hour meter, odometer and fault warnings. Password-protected parameters and monitoring capability.	✓	✓
SAFETY	Reverse Alarm, Deadman Seat Switch, Emergency Stop Button, Horn	✓	✓
ACCESSORIES	DC/DC converter for 12-volt accessories, front and rear rubber bumpers	✓	✓

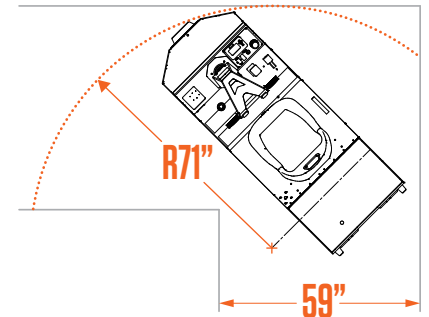
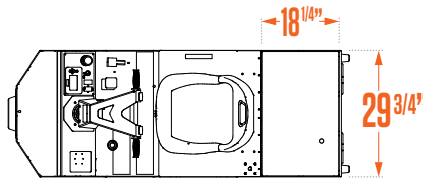
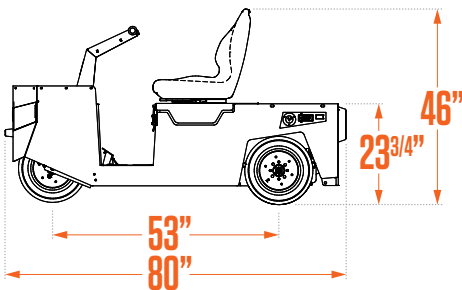

UNBEATABLE VEHICLES BACKED BY UNBEATABLE WARRANTIES

3-Year limited warranty on all Motrec vehicles with AC technology, our MS-260 stock chaser and all Motrec trailers.



1 866 846-3558
MOTREC.COM

POPULAR OPTIONS

MT 180

MODELS
36V | 48V

GET THE MOST FROM YOUR FLEET

- 1 ALL-STEEL CAB, WITH OR WITHOUT DOORS**
Keep operators comfortable, safe & productive at all times – indoors or out, fair weather or not. Our cabs come with a long list of standard & optional features.
- 2 LIGHTS**
Maximize vehicle visibility & everyone's safety with a blue safety light, strobe light, tail and brake lights and more.
- 3 WHEELS**
Motrec offers a wide range of wheels to handle your specific use: non-marking solid tire wheel, rubber solid tire wheel, pneumatic on rim, traction tire, and more. Further with our wide range of protectors.

- 4 HITCHES & QUICK HITCH RELEASE**
A must-have for attaching a trailer to boost cargo capacity. A wide range of hitches & hitch accessories to make attaching loads quick, easy & worry free.
- 5 FOLDING SEAT AND REAR FOOTSTEP**
Our folding seat gives you more versatility. You can quickly go from 1 to 2 passengers, or maximize your rear cargo space by folding the passenger seat.
- 6 TRAILERS**
Boost your load-handling muscle with trailers of all sizes and load capacities.



For compatibility, please contact your Motrec dealer. Options may vary from illustrations provided.

PERFORMANCE

- TOWING CAPACITY 10,000 lbs.
- WIDTH 29¾"
- SPEED 8 mph
- TURNING RADIUS 71"

RECOMMENDED INDUSTRIES

Aluminum smelters and metallurgies

Warehousing, logistics and distribution

Greenhouses, agriculture and plan nursery



1 866 846-3558
MOTREC.COM