

MP 250

MODELS
24V | 36V



OFTEN IMITATED BUT NEVER EQUALED

It's no surprise the competition envies our original design. This agile and versatile personnel carrier has it all: A narrow deck, four wheels for greater stability on rough terrain, powerful motor, rugged automotive differential and larger self-adjusting drum brakes, all-steel unibody construction, bolt-on front bumper and side bar protection, easy-to-access under-seat battery compartment... The list keeps going. It can also pull up to 6,000 lbs.*, making it a great backup tow tractor.

MODELS	LOAD CAPACITY (LBS.)	TOWING CAPACITY (LBS.)	PASSENGERS	SPEED (mph)	TURNING RADIUS (in)
24V	500	2,000	1	7	75
36V	500	6,000	1	8	75

FEATURES

- 1 Reinforced bolt-on bumper and rear wheel guards
- 2 Easy maintenance
- 3 Fatigue- and accident-saving ergonomic suspension
- 4 All-steel monocoque construction designed to last.
- 5 Powder coating and protection, very resistant









CONTACT-US 1 866 846-3558

MOTREC.COM

SPECIFICATIONS

MP 250

PERFORMANCE		24V	36V
 LOAD CAPACITY		500 lbs - 227 kg	500 lbs - 227 kg
 TOWING CAPACITY		2000 lbs - 907 kg	6000 lbs - 2722 kg
 SPEED		7 mph - 11 km/h	8 mph - 13 km/h
 TURNING RADIUS		75 in - 1,905 mm	75 in - 1,905 mm
 PASSENGERS		1 - 2	1 - 2
POWERTRAIN			
MOTOR	Shunt motors	6 HP	10 HP
CONTROLLER	SEPEX Electronic speed controller	✓	✓
DRIVE AXLE	Helical gear differential	✓	✓
BRAKES	Dual self-adjusting mechanical drum brakes on rear, hand lever parking brake, regenerative braking	✓	✓
WHEELS	4,8x8 LRC pneumatic tires	✓	✓
TRANSMISSION	Direct drive	✓	✓
SUSPENSION	Dual coil springs & shock absorber on front & rear	✓	✓
CHASSIS			
BODY	All steel unibody construction	✓	✓
COLOR	Security orange or federal yellow (optional colors available)		
LIGHTS	LED headlight & tail/brake light	✓	✓
OPERATOR COMPARTMENT			
STEERING	Automotive steering wheel	✓	✓
SEATS	Bucket seat on slide adjusters	✓	✓
INDICATORS	Battery status indicator	✓	✓
SAFETY	Reverse alarm, Deadman foot switch, Horn	✓	✓
ACCESSORIES	Bolt-on bumpers and rear wheel guards, 24V accessories to equalize cells and extend battery	✓	✓

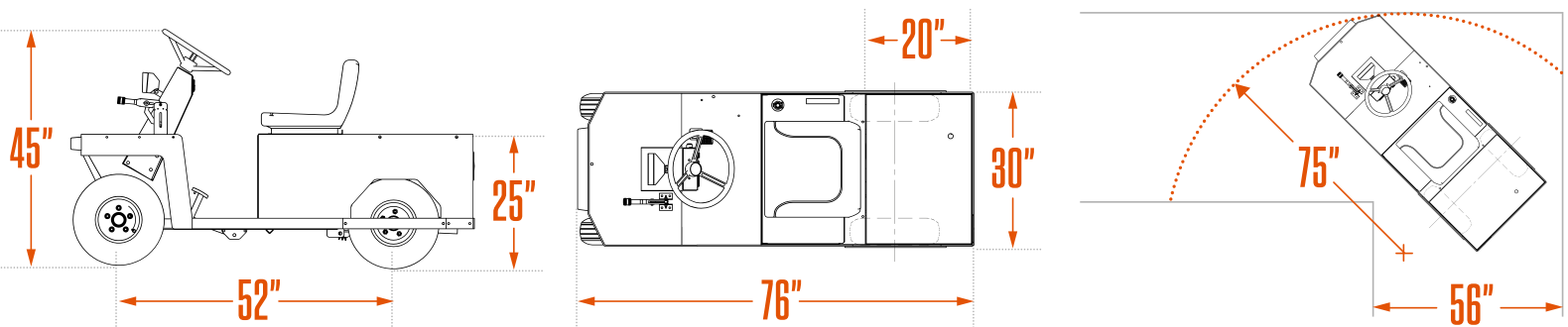

UNBEATABLE VEHICLES BACKED BY UNBEATABLE WARRANTIES

2-Year limited warranty on all Motrec vehicles with DC technology.



1 866 846-3558
MOTREC.COM